

SmartVerge® Dry Verge Systems – Ridge End Caps

CODE **GDV**

Product Codes:

Round Ridge End Cap
Angled Ridge End Cap

GDV-END-R
GDV-END-A

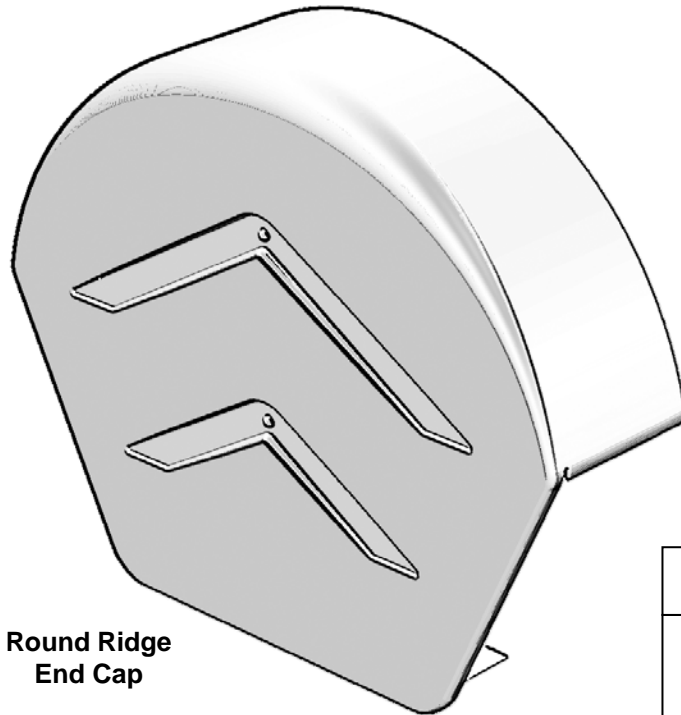

Round Ridge End Cap

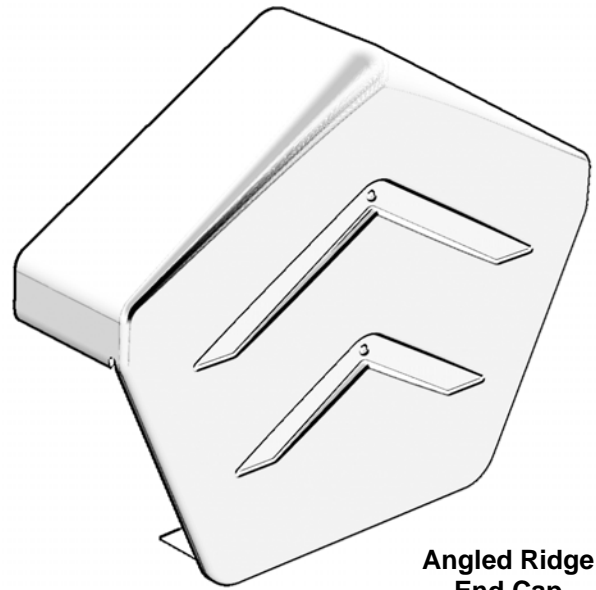

Angled Ridge End Cap

References:

BSI: British Standard 5534:2003
BSI: British Standard 6399-2:1997
NHBC Standards Chapter 7.2 Pitched Roofs

Description:

The Manthorpe Ridge End Caps work in conjunction with the Manthorpe SmartVerge® Dry Verge System and SmartVerge® Linear Dry Verge System to provide a neat and attractive finish for most makes of Round and Angled Concrete Ridge Tiles.

The Ridge End Caps provide durable protection at each end of the ridge, eliminating problems caused by water penetration whilst preventing the entry of birds and large insects into the roof cavity.

Each Ridge End Cap is supplied with fixings and fitting instructions and can be quickly and easily fixed directly to the Ridge Batten(s) in all weather conditions.

Features:

Easy to fix and maintenance free.

Mortar-free solution allows fixing in all weather conditions.

Suitable for new build or refurbishment situations on roofs of 15° to 55° pitch.

Prevents entry of birds and large insects into the roof cavity.

Suitable for most makes of half round, segmental, universal angle & modern ridge tiles.

Complies with BS 5534 requirements for mechanical fixing.

MANTHORPE BUILDING PRODUCTS LTD
MANTHORPE HOUSE
BRITAIN DRIVE
CODNOR GATE BUSINESS PARK
RIPLEY
DERBYSHIRE DE5 3ND

TEL: 01773 514 200
FAX: 01773 514 262
EMAIL: sales@manthorpe.co.uk
WEB: www.manthorpe.co.uk

DRN R.P

Date 4.6.07

DRG No

Issue

The company maintains a policy of continuous development of its product range and reserves the right to amend the specification without notice.

MBP 8227
(PAGE 1 OF 2)

D

SmartVerge® Dry Verge Systems – Ridge End Caps

CODE **GDV**

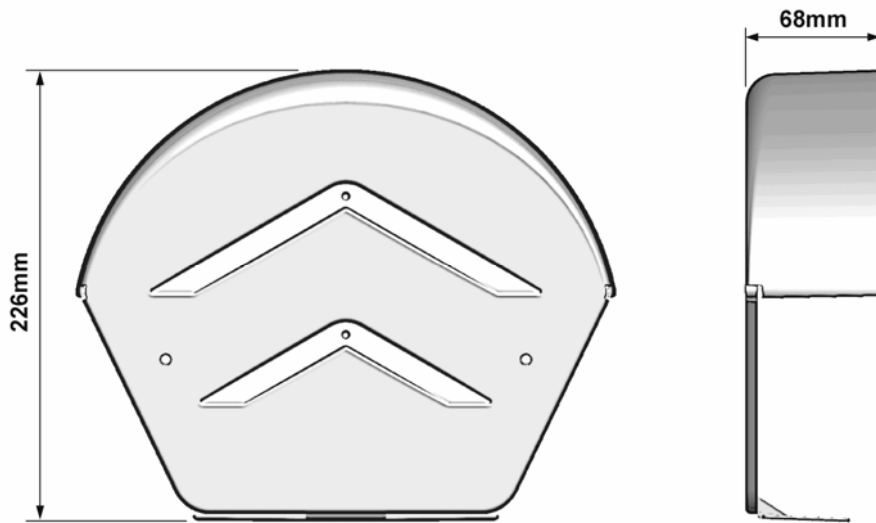



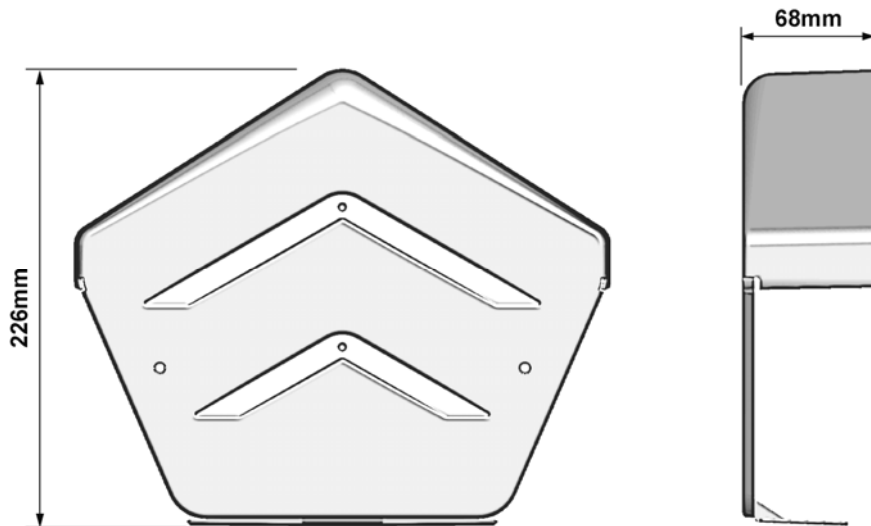

Round Ridge End Cap GDV-END-R



Angled Ridge End Cap GDV-END-A

PACKING DETAILS	Ridge End Pack contains 2 Round <u>or</u> Angled Ridge End Caps, 4 screws and Fixing Instructions 10 Packs per Box.
WEIGHT	4.5kg per Box
MATERIAL	Unplasticized Polyvinyl Chloride (uPVC)
MANUFACTURING PROCESS	Injection Moulded

COLOUR VARIATIONS	Slate Grey (GR)	
	Black (BL)	
	White (WH)	
	Terracotta (TR)	
	Dark Brown (BR)	

MANTHORPE BUILDING PRODUCTS LTD
MANTHORPE HOUSE
BRITAIN DRIVE
CODNOR GATE BUSINESS PARK
RIPLEY
DERBYSHIRE DE5 3ND

TEL: 01773 514 200
FAX: 01773 514 262
EMAIL: sales@manthorpe.co.uk
WEB: www.manthorpe.co.uk

DRN R.P

Date 4.6.07

The company maintains a policy of continuous development of its product range and reserves the right to amend the specification without notice.

DRG No

MBP 8227
(PAGE 2 OF 2)

Issue

D